

**PRM**

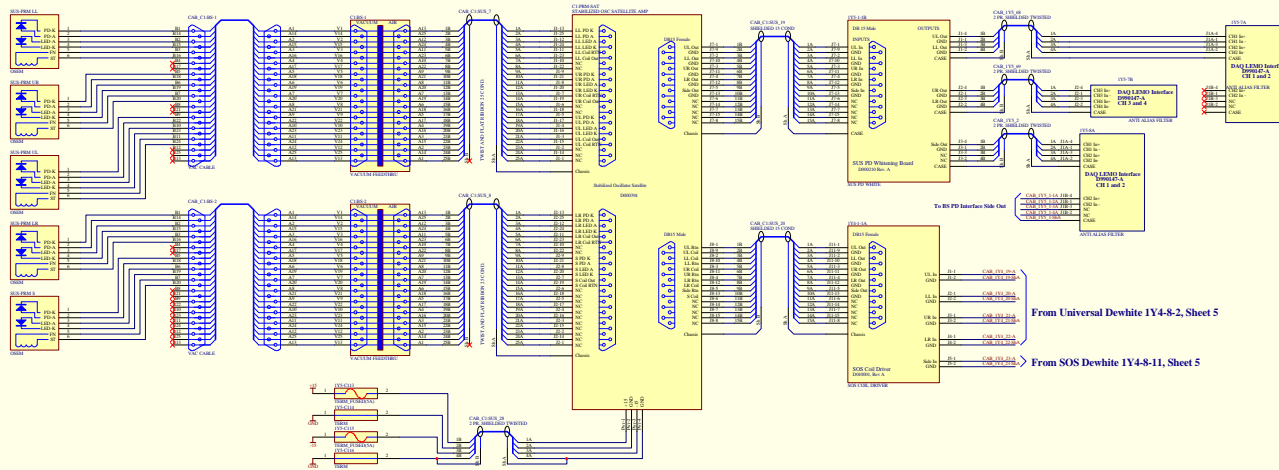

From Universal Dewhite 1Y4-8-2, Sheet 5

From SOS Dewhite 1Y4-8-11, Sheet 5

**BS**

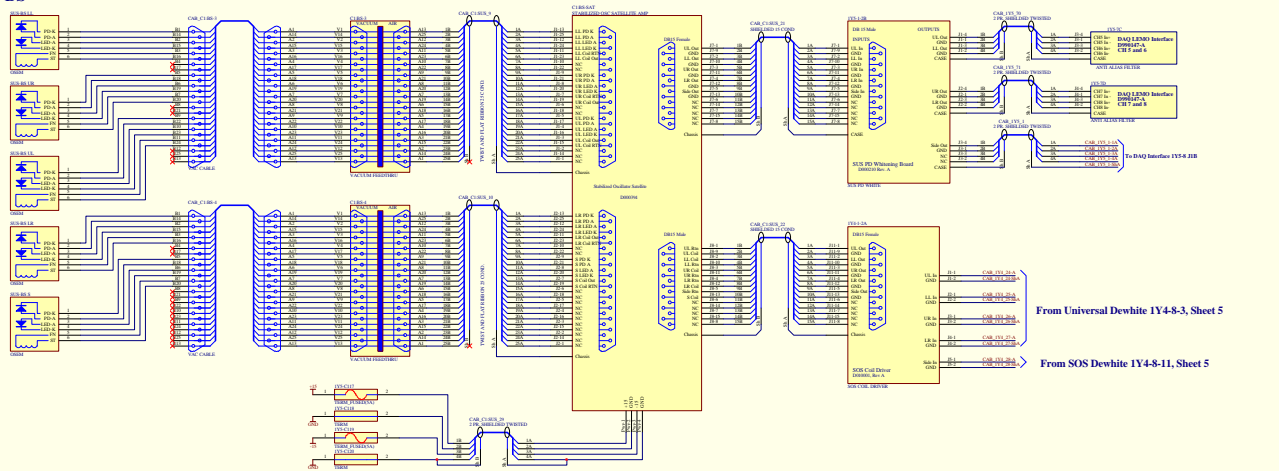

From Universal Dewhite 1Y4-8-3, Sheet 5

From SOS Dewhite 1Y4-8-11, Sheet 5

Title		Revision	
Title: <b>allin SOS Controls Wiring</b>		Revision: 01	
Author:	Drawn:	Checked:	Approved:
Author: [Name]	Drawn: [Name]	Checked: [Name]	Approved: [Name]
Date:	Scale:	Sheet:	Total:
Date: [Date]	Scale: [Scale]	Sheet: [Sheet]	Total: [Total]

**ITMX**

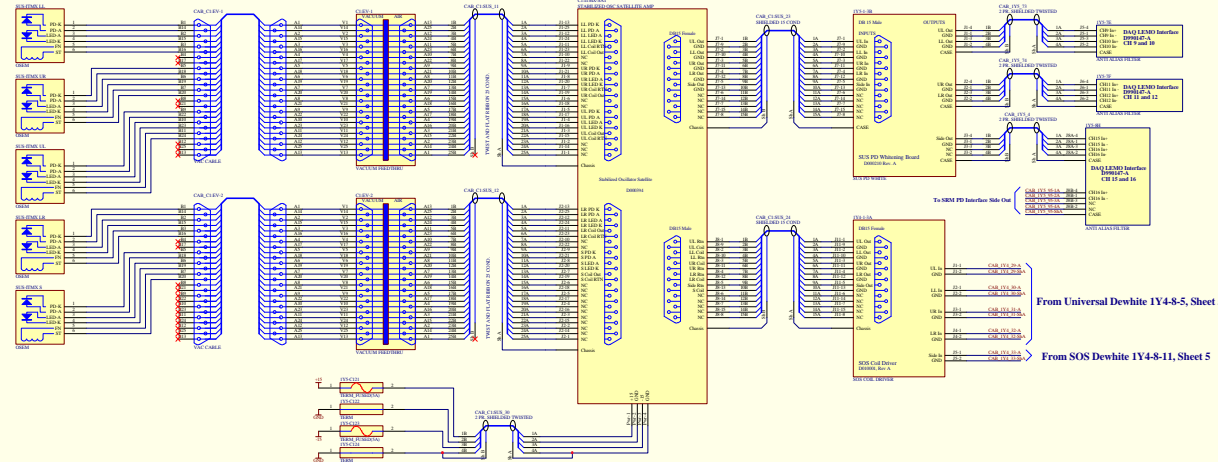

From Universal Dewhite 1V4-8-5, Sheet 5

From SOS Dewhite 1V4-8-11, Sheet 5

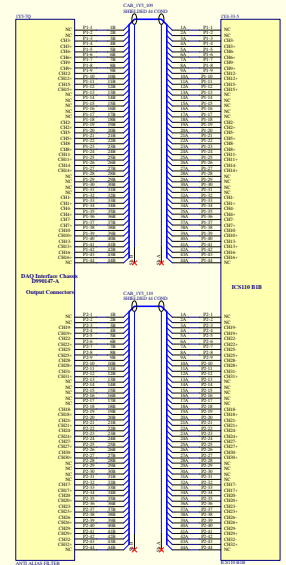

Channel Assignments	
Channel #	Signal
1	BCM L.R.PD
2	BCM L.L.PD
3	BCM R.R.PD
4	BCM R.L.PD
5	BS L.R.PD
6	BS L.L.PD
7	BS R.R.PD
8	BS R.L.PD
9	ETMX L.L.PD
10	ETMX L.R.PD
11	ETMX R.R.PD
12	ETMX R.L.PD
13	ETMY L.L.PD
14	ETMY L.R.PD
15	ETMY R.R.PD
16	ETMY R.L.PD
17	SSM L.L.PD
18	SSM L.R.PD
19	SSM R.R.PD
20	SSM R.L.PD
21	MC1 L.L.PD
22	MC1 L.R.PD
23	MC1 R.R.PD
24	MC1 R.L.PD
25	MC2 L.L.PD
26	MC2 L.R.PD
27	MC2 R.R.PD
28	MC2 R.L.PD
29	MC3 L.L.PD
30	MC3 L.R.PD
31	MC3 R.R.PD
32	MC3 R.L.PD

**ITMY**

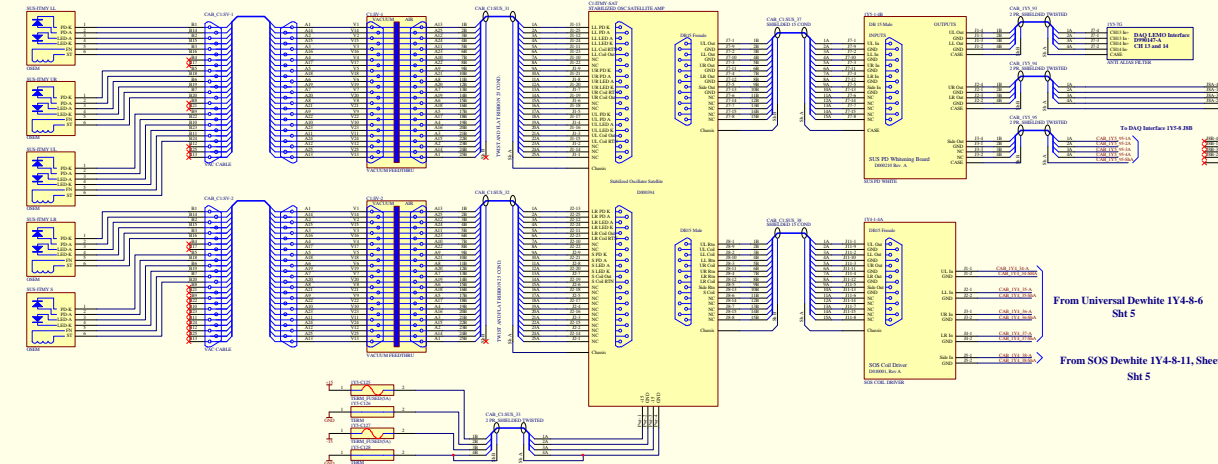

From Universal Dewhite 1V4-8-6 Sht 5

From SOS Dewhite 1V4-8-11, Sheet 5 Sht 5



**MCI**

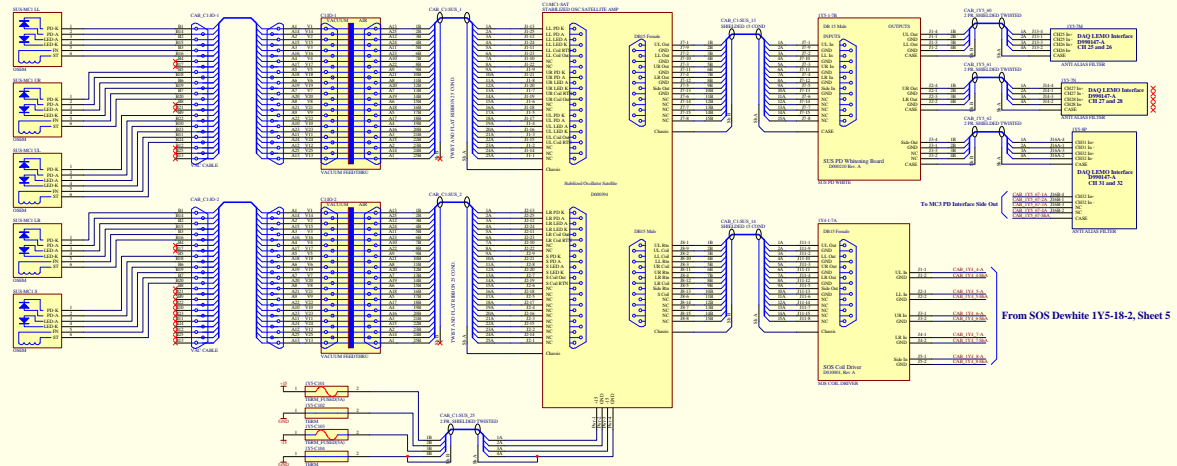

From SOS Dewhite 1V5-18-2, Sheet 5

**MC3**

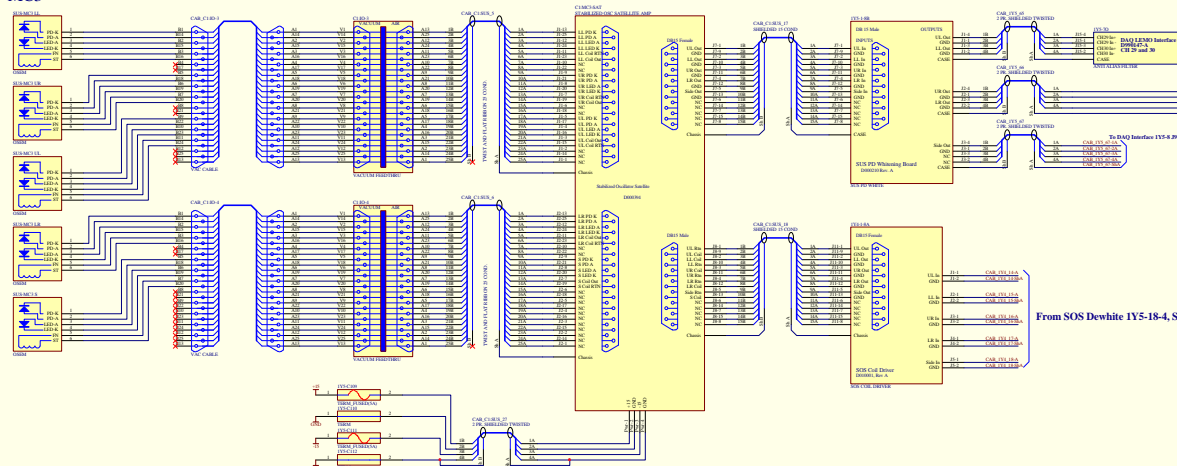

From SOS Dewhite 1V5-18-4, Sheet 5

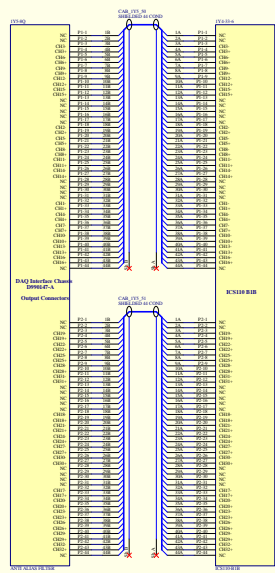

Channel Assignments	
Channel #	Signal
1	RM Side PD
2	BS Side PD
3	NC
4	NC
5	NC
6	NC
7	NC
8	NC
9	NC
10	NC
11	NC
12	NC
13	NC
14	NC
15	ITMAX Side PD
16	ITM4 Side PD
17	SBM Side PD
18	MC2 Side PD
19	NC
20	NC
21	NC
22	NC
23	NC
24	NC
25	NC
26	NC
27	NC
28	NC
29	NC
30	NC
31	MC1 Side PD
32	MC3 Side PD



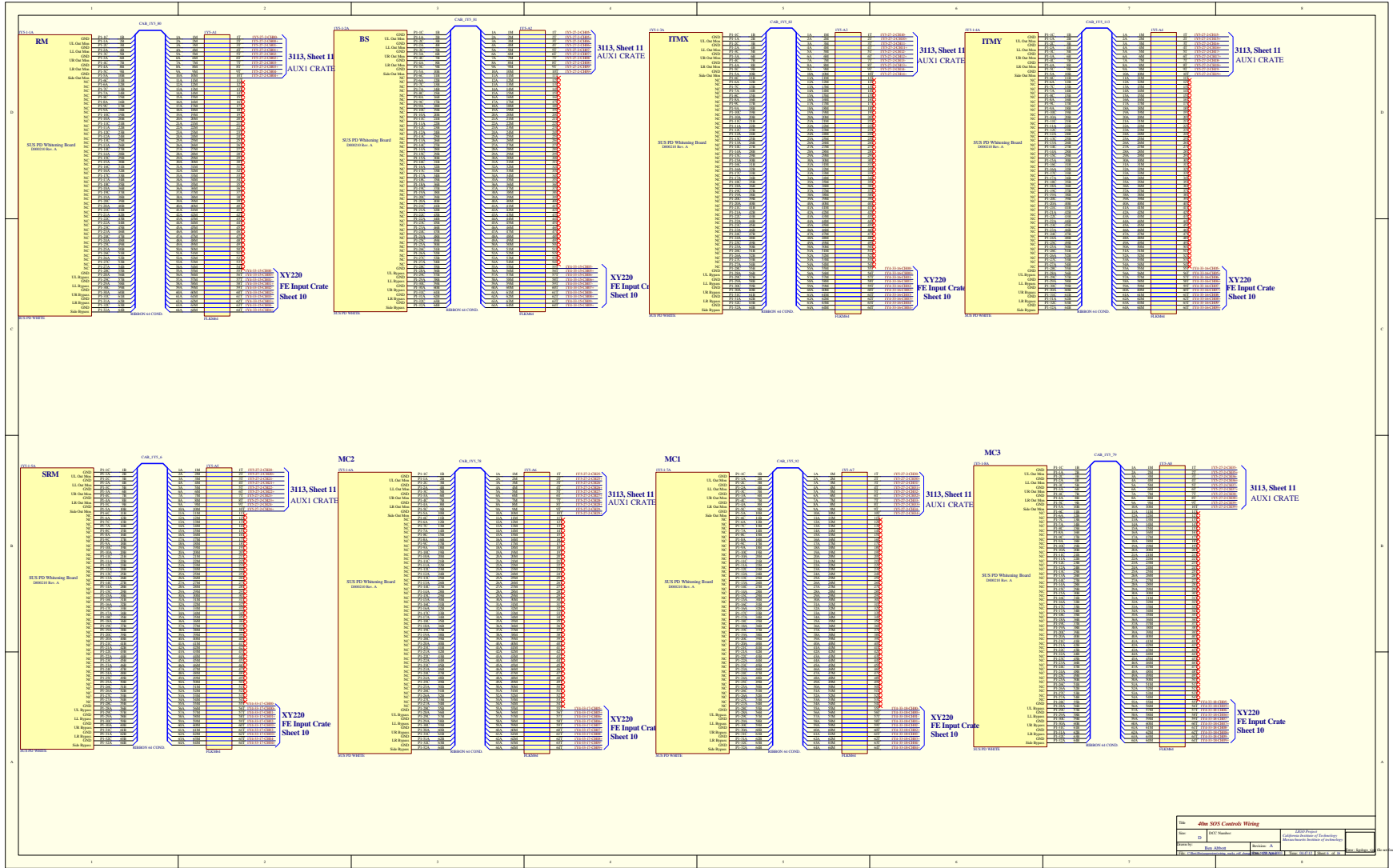

Title		4th SOS Controls Wiring	
Rev	0	Rev	0
Drawn	By: [Name]	Checked	By: [Name]
Scale		Scale	

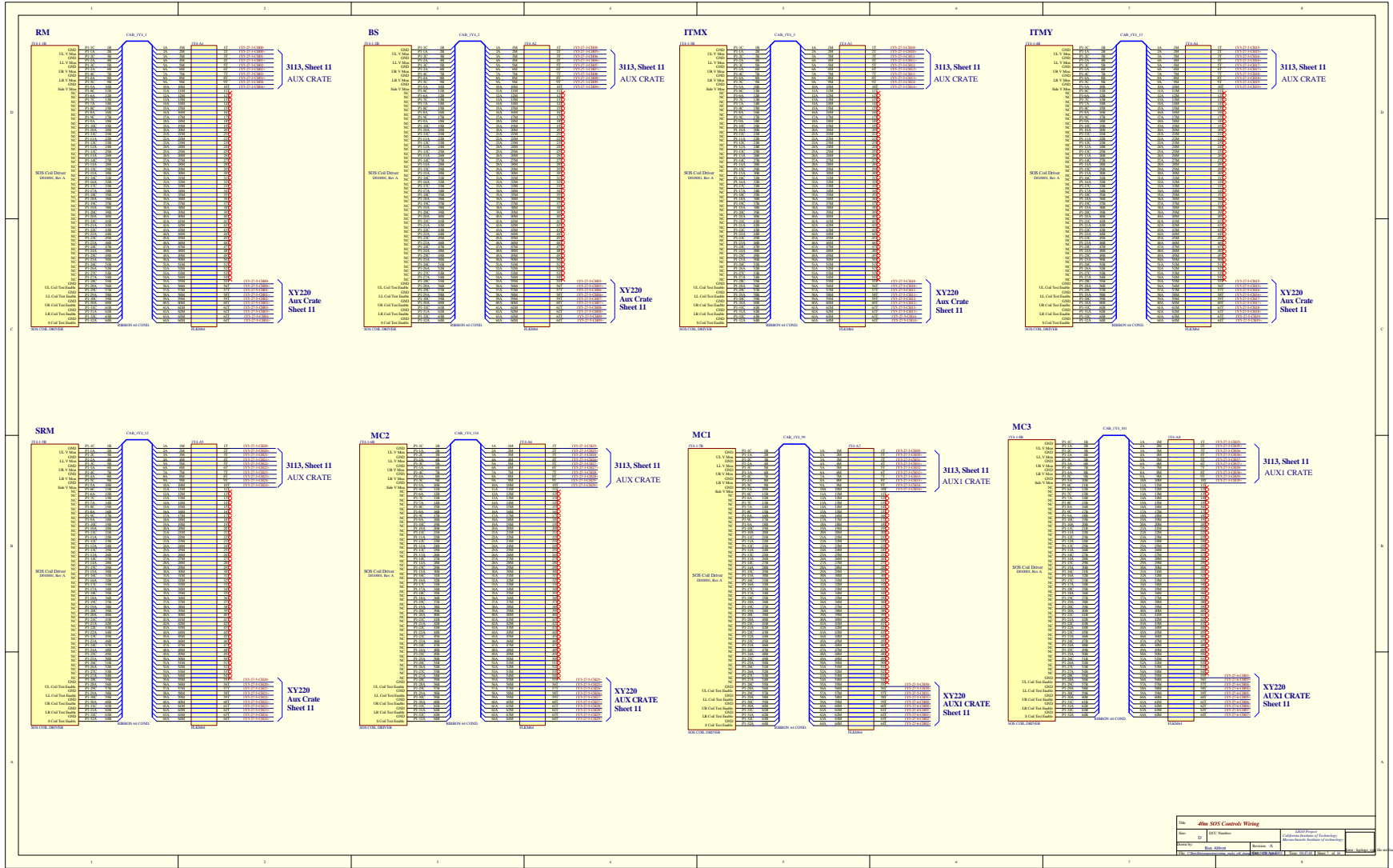

Title		4444 SOS Controls Wiring	
Rev	0	DOC Number	4444-0000
DATE	01/15/2000	Rev. Author	John J. ...
DATE	01/15/2000	Rev. Date	01/15/2000



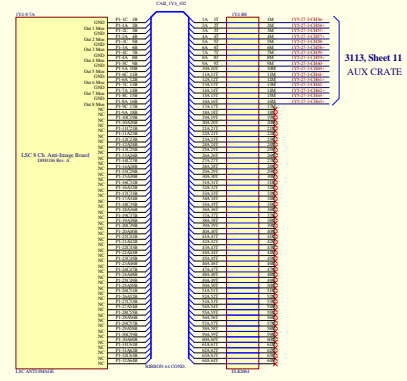
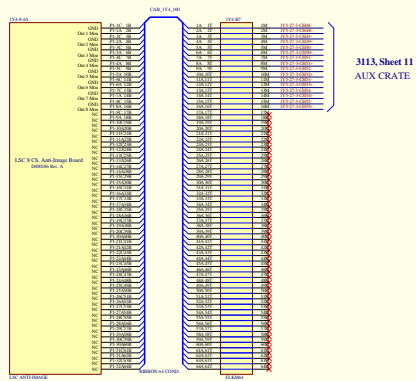
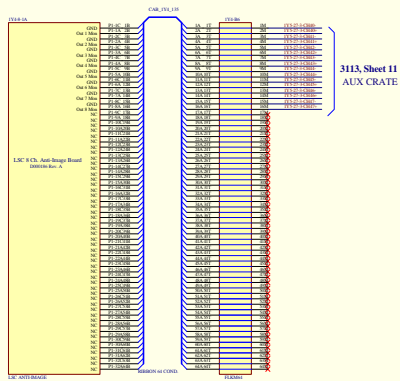

Rev:	DWG Number:	Project Name:	Sheet No.:
001	313-11	313-11	11
Author:	Designer:	Checker:	Approver:

# Front End Input Crate

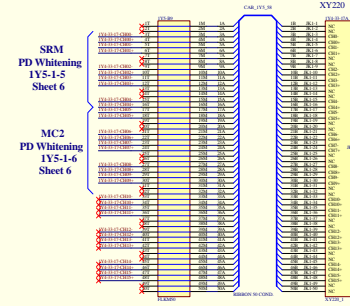
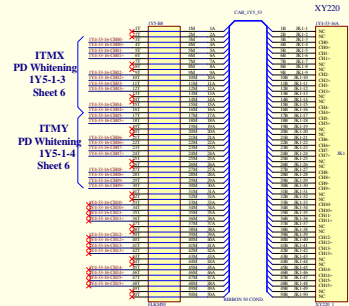
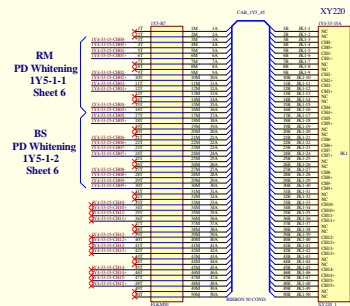

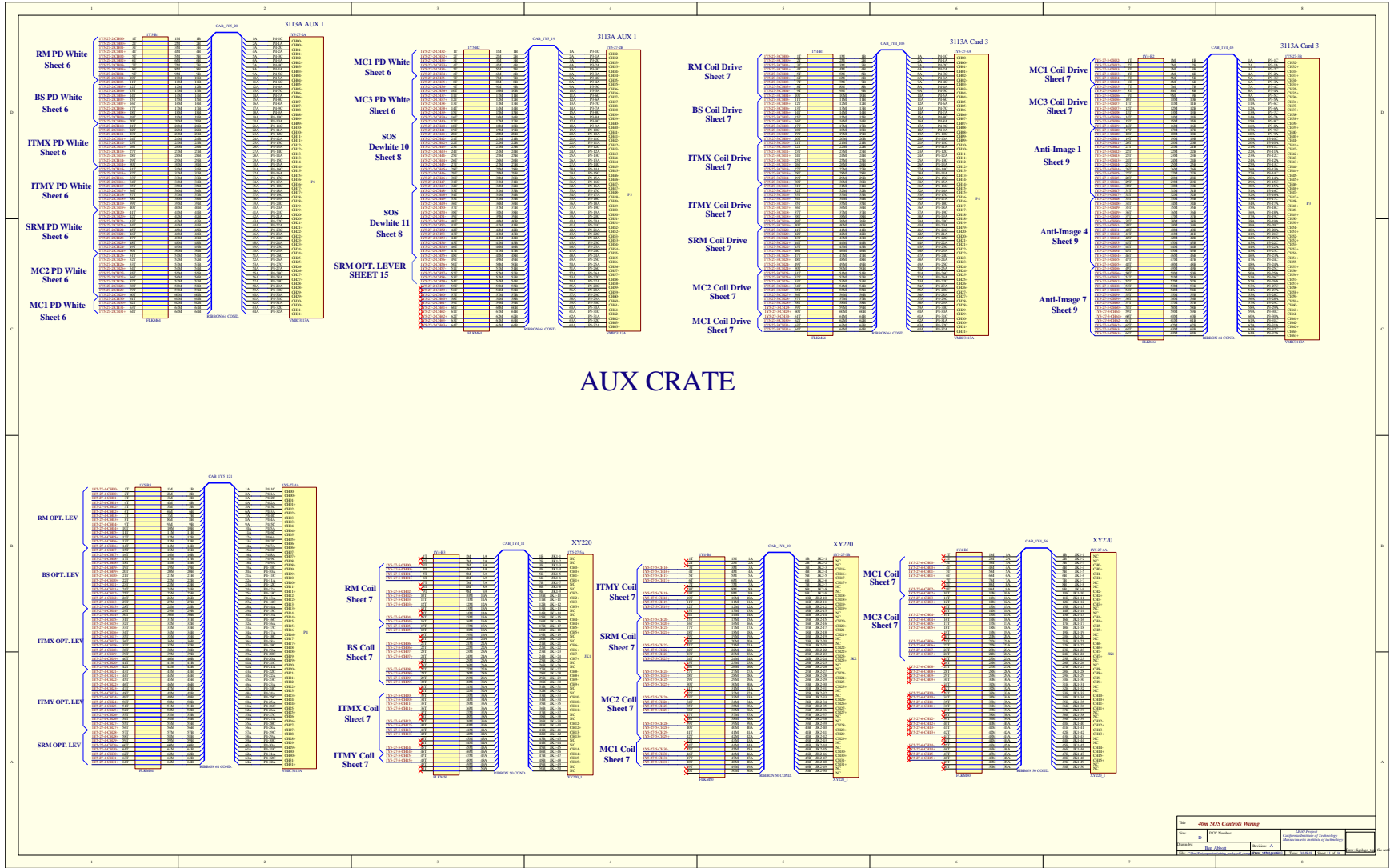



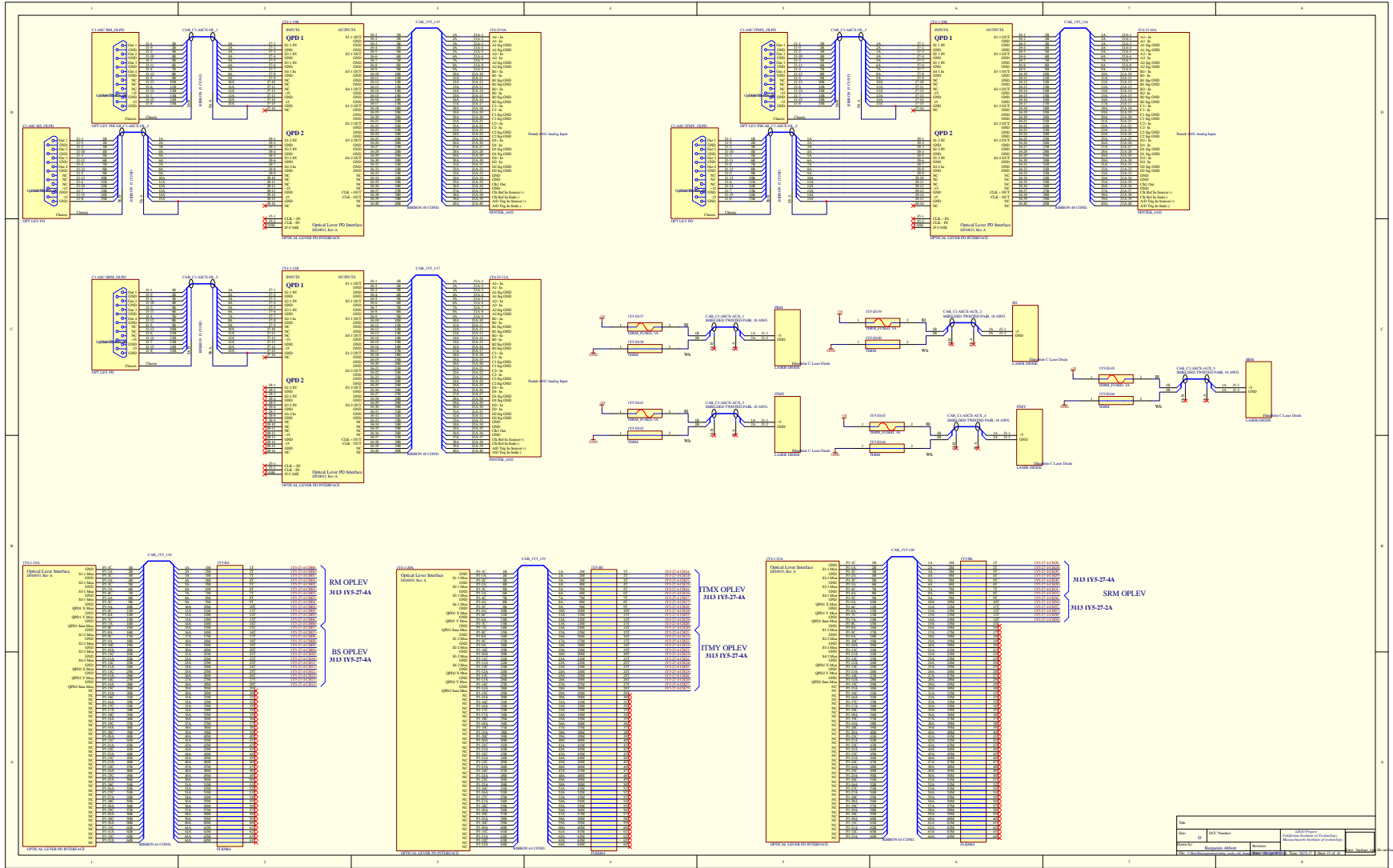

**RACK 1Y5**

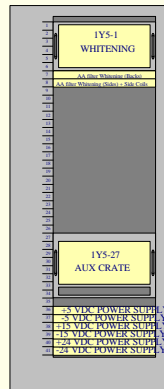

**1Y5-1**

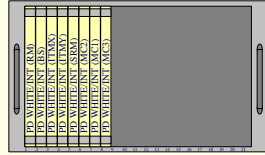

**1Y5-27**

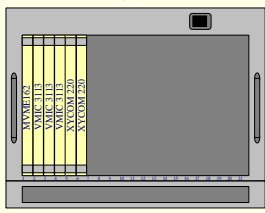

**RACK 1Y4**

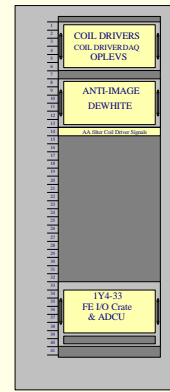

**1Y4-1**

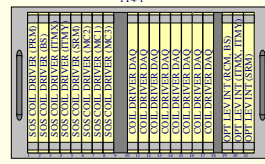

**1Y4-8**

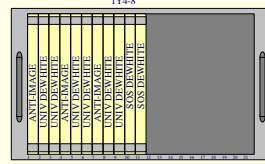

**1Y4-33**

